

WE RECOMMEND A MINIMUM OF 70mm FOR TALL FILLERS

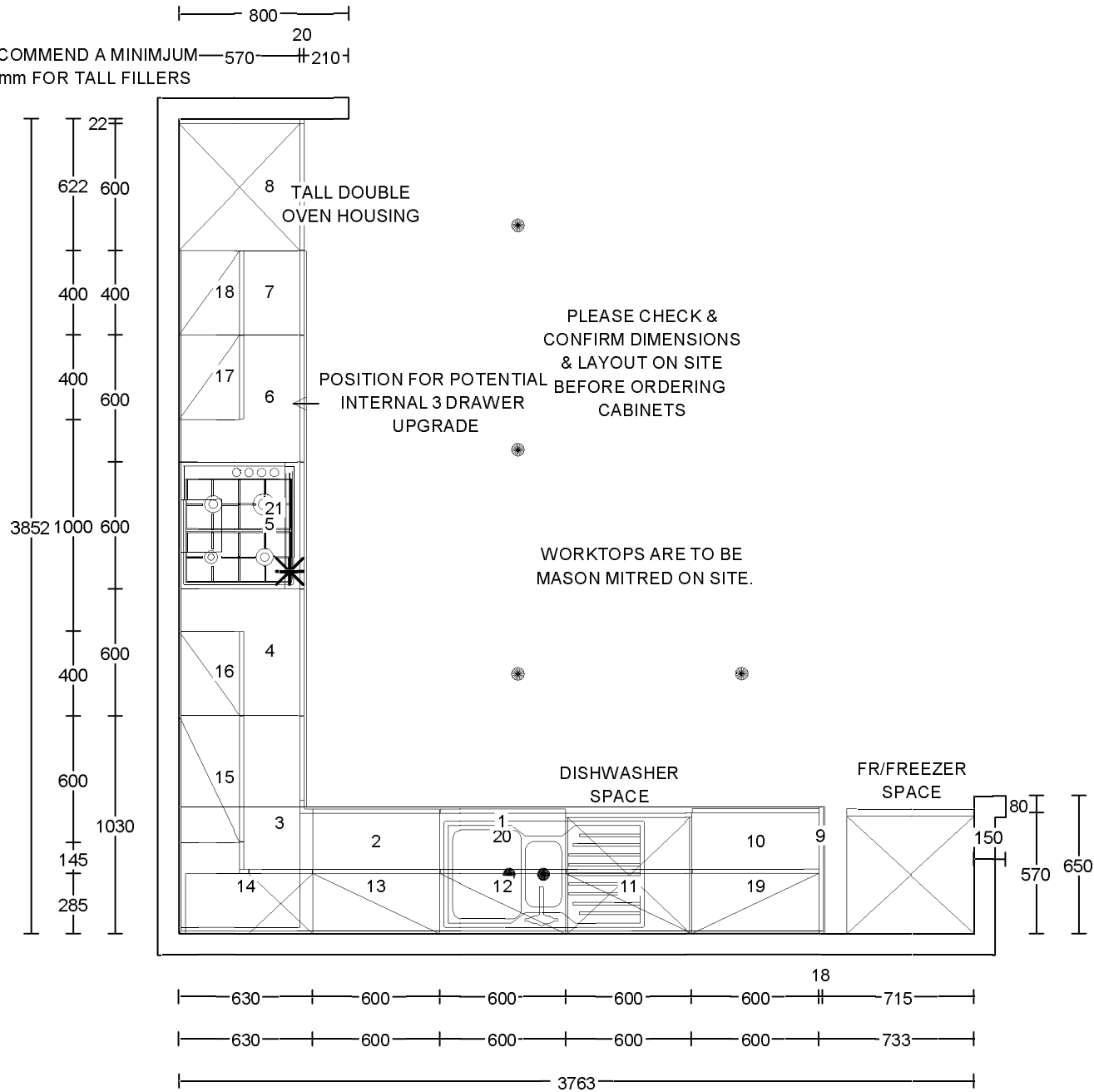

Client:	BLOOR HOMES	Drawing No:	722805__
Site:	CLASSICS RANGE	Revision No:	
House Type:	CLASSIC 400 HILCOTT EXCL. UTILITY	Scale:	Scale-to-fit
House Type 2:	STANDARD		



THIS DRAWING AND THE COPYRIGHT THEREIN IS THE PROPERTY OF THE SYMPHONY GROUP PLC. THIS DRAWING IS ISSUED ON THE CONDITION THAT IT MUST NOT BE USED, COPIED OR EXHIBITED WITHOUT THE WRITTEN PERMISSION OF THE SYMPHONY GROUP PLC. ANY COMPONENTS OR ARTICLES MADE IN ACCORDANCE WITH THIS DRAWING MUST NOT BE USED FOR ANY OTHER PURPOSE THAN FOR WHICH THE DRAWING IS ISSUED.

THIS PLAN IS OFFERED AS A GUIDE ONLY FOR APPROVAL BY OUR CUSTOMER. NO RESPONSIBILITY IS UNDERTAKEN FOR ITS ACCURACY IN RELATION TO ORDERS PLACED FOR THE FITTING OF OUR GOODS WITHIN THE DIMENSIONS SHOWN.

**SCHEDULE &
CUBIC CAPACITY**



Client Name:	BLOOR HOMES	Site Name:	CLASSICS RANGE 2018 - LEVEL 2 ISSUE 4
House Type:	CLASSIC 400 HILCOTT EXCL. UTILITY STANDARD		
Drawing No:	722805__	Revision No:	
Date Drawn:	Fri, Jan 7, 2022	Revision Date:	
Designed By:	CARA NORTCLIFF	Quote No:	

Items on Plan:

Default Style

Plan No.	Qty	Code	Hdg	Description	Dims	CC (M3)
1	1	SU66SLF	R	Sink Unit FH w/Sink Liner	600/600/870	0.20
2	1	BU66F	R	Base Unit FH	600/600/870	0.20
3	1	CB106FBFP	L	Corner Base FH (400 Door) (Flexi C/Post)	1000/600/870	0.34
4	1	BU66F	L	Base Unit FH	600/600/870	0.20
5	1	BU66F3IDC	L	Base Unit FH w/1x Shallow Int. Drw & 2x Deep Int. Drw	600/600/870	0.20
5.1	1	HOBSHIELD6		Hobshield	600	
6	1	BU66F	R	Base Unit FH	600/600/870	0.20
7	1	BU46F	R	Base Unit FH	400/600/870	0.13
8	1	OH663A	R	Dbl Oven Hsg. (3A)	600/600/2100	0.28
9	1	BBU6592C		Carcase Matched Base Blender	650/920	
10	1	BU66F	L	Base Unit FH	600/600/870	0.20
11	1	WU672	R	Wall Unit	600/300/724	0.10
12	1	WU672	R	Wall Unit	600/300/724	0.10
13	1	WU672	R	Wall Unit	600/300/724	0.10
14	1	CWU672	R	Corner Wall, No C/Post (300 Door)	600/300/724	0.10
15	1	WU672	L	Wall Unit	600/300/724	0.10
16	1	WU472	L	Wall Unit	400/300/724	0.07
17	1	WU472	R	Wall Unit	400/300/724	0.07
18	1	WU472	R	Wall Unit	400/300/724	0.07
19	1	WU672	L	Wall Unit	600/300/724	0.10
	1	HOBSHIELD6		Hobshield	600	
	1	CONPLINTH		Continuous Plinth (For Tall Filler)	2600	
	1	FRONTPNL72		Frontal Matched Filler Panel (For C/Post)	720	

Total cubic metres of storage

2.76

Worktop Details:

Default Style

Plan No.	Qty	Code	Description	Dims
----------	-----	------	-------------	------

20	1	PWT	40mm PVC Edged / 40mm Premium / 30mm Hi Def Worktop	3200/600
21	1	PWT	40mm PVC Edged / 40mm Premium Worktop	2800/600
	1	PFUP3095	Laminate Upstand	3050/95
	1	PFUP3095	Laminate Upstand	3000/95
	1	PFUP3095	Laminate Upstand	3000/95

Accessories and Trims:

Default Style

Qty	Code	Description	Dims
2	BRKPLINTH	Plinth Corner Bracket (Pack of 2)	
3	CONPLINTHC	Carcase Matched Continuous Plinth w/Plinth Seal	2600
1	CTRAYVFH6	Standard Internal Cutlery Tray (For BU66F3ID/BU66F4ID)	600
2	RUNITPROTECT	Kitchen Protective Material	
1	SBACK675	Stainless Steel Splashback	600/750
1	TOPSEALBOLT	Topseal Easibolt Pack	
1	VENTGRILL200	Ventilation Grill - Flowrate	200cm2

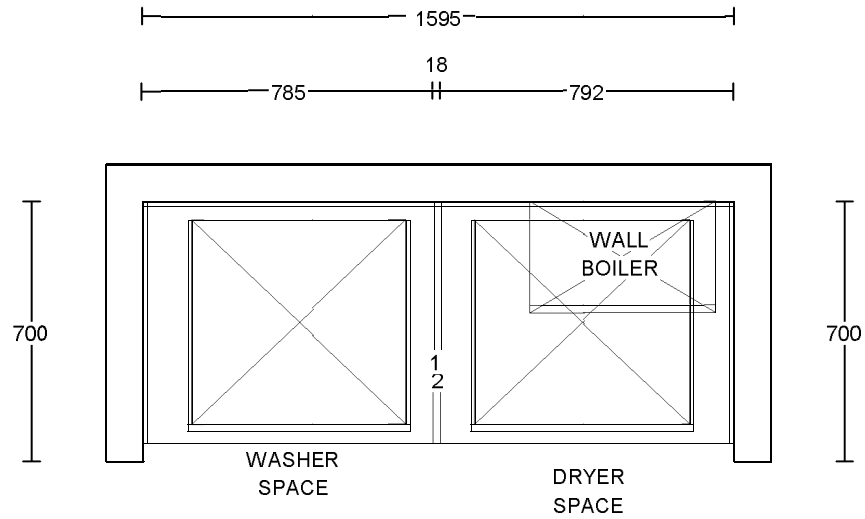

650mm DEEP WORKTOPS

PLEASE CHECK &
CONFIRM DIMENSIONS
& LAYOUT ON SITE
BEFORE ORDERING
CABINETS

Client:	BLOOR HOMES	Drawing No:	722805UA
Site:	CLASSICS RANGE	Revision No:	A
House Type:	CLASSIC 400 HILCOTT UTILITY	Scale:	Scale-to-fit
House Type 2:	STANDARD		

Symphony[®]

**SCHEDULE &
CUBIC CAPACITY**

Symphony[®]

Client Name:	BLOOR HOMES	Site Name:	CLASSICS RANGE 2018 - LEVEL 2 ISSUE 4
House Type:	CLASSIC 400 HILCOTT UTILITY STANDARD		
Drawing No:	722805UA	Revision No:	A
Date Drawn:	Fri, Jan 7, 2022	Revision Date:	13.12.21
Designed By:	CARA NORTCLIFF	Quote No:	

Items on Plan: Default Style

Plan No.	Qty	Code	Hdg	Description	Dims	CC (M3)
1	1	BBU6592C		Carcase Matched Base Blender	650/920	
	1	BBU6592C		Carcase Matched Base Blender 650/920 TO BOX BOILER PIPES		
	1	BBU6592C		Carcase Matched Base Blender 650/920 TO BOX BOILER PIPES		

Total cubic metres of storage

Worktop Details: Default Style

Plan No.	Qty	Code	Description	Dims
2	1	PWT	40mm PVC Edged / 40mm Premium / 30mm Hi Def Worktop	1700/650
	1	PFUP3095	Laminate Upstand	3050/95

Accessories and Trims: Default Style

Qty	Code	Description	Dims
1	RUNITPROTECT	Kitchen Protective Material	

WE RECOMMEND A MINIMUM OF 70mm FOR TALL FILLERS

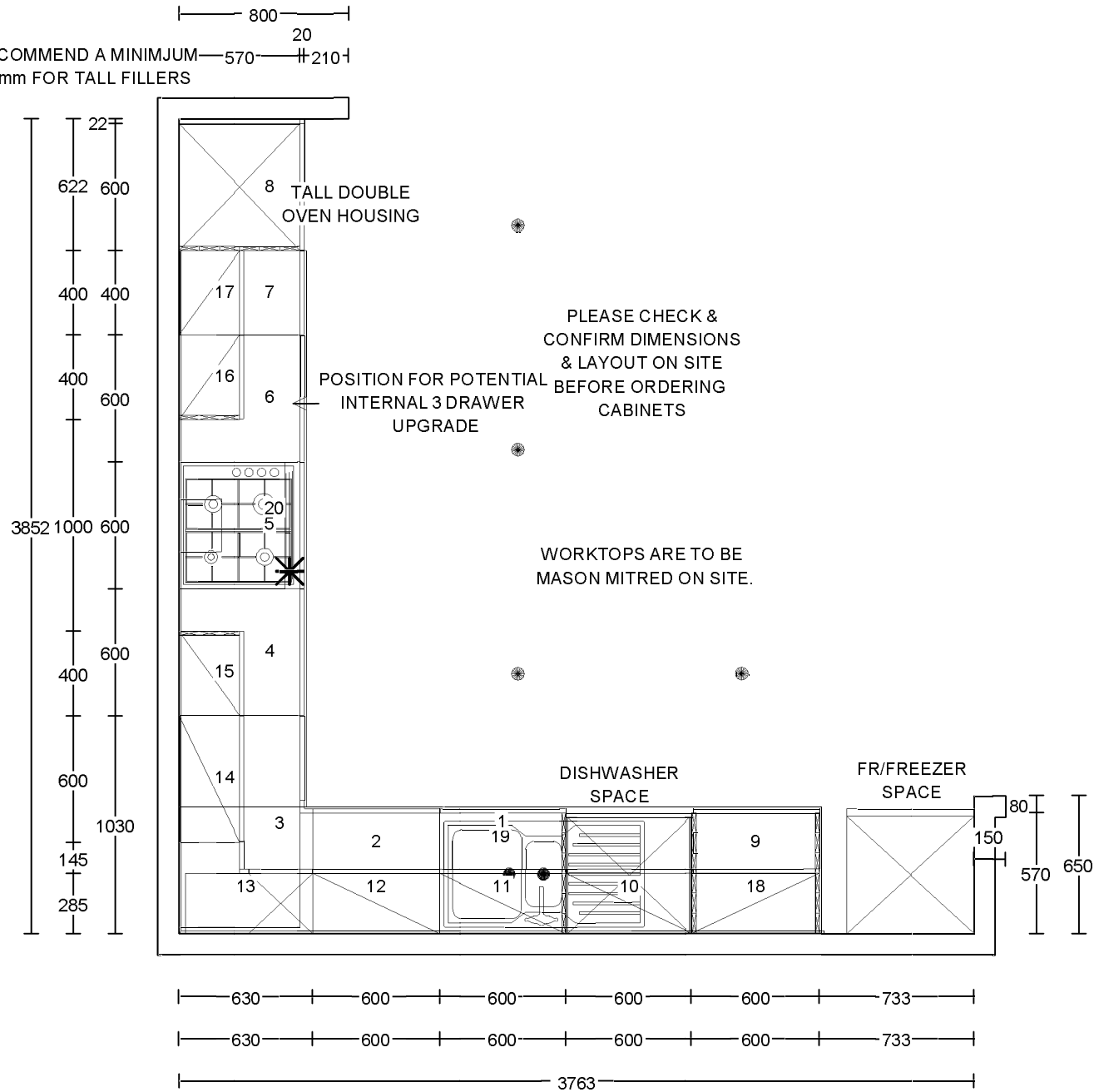

Client:	BLOOR HOMES	Drawing No:	722806__
Site:	CLASSICS RANGE	Revision No:	
House Type:	CLASSIC 400 HILCOTT EXCL. UTILITY	Scale:	Scale-to-fit
House Type 2:	UPGRADE		



THIS DRAWING AND THE COPYRIGHT THEREIN IS THE PROPERTY OF THE SYMPHONY GROUP PLC. THIS DRAWING IS ISSUED ON THE CONDITION THAT IT MUST NOT BE USED, COPIED OR EXHIBITED WITHOUT THE WRITTEN PERMISSION OF THE SYMPHONY GROUP PLC. ANY COMPONENTS OR ARTICLES MADE IN ACCORDANCE WITH THIS DRAWING MUST NOT BE USED FOR ANY OTHER PURPOSE THAN FOR WHICH THE DRAWING IS ISSUED.

THIS PLAN IS OFFERED AS A GUIDE ONLY FOR APPROVAL BY OUR CUSTOMER. NO RESPONSIBILITY IS UNDERTAKEN FOR ITS ACCURACY IN RELATION TO ORDERS PLACED FOR THE FITTING OF OUR GOODS WITHIN THE DIMENSIONS SHOWN.

**SCHEDULE &
CUBIC CAPACITY**



Client Name:	BLOOR HOMES	Site Name:	CLASSICS RANGE 2018 - LEVEL 2 ISSUE 4
House Type:	CLASSIC 400 HILCOTT EXCL. UTILITY UPGRADE		
Drawing No:	722806__	Revision No:	
Date Drawn:	Fri, Jan 7, 2022	Revision Date:	
Designed By:	CARA NORTCLIFF	Quote No:	

Items on Plan:

Default Style

Plan No.	Qty	Code	Hdg	Description	Dims	CC (M3)
1	1	SU66SLFGL	R	Sink Unit FH w/Sink Liner (LH End)	600/600/870	0.20
2	1	BU66F	R	Base Unit FH	600/600/870	0.20
3	1	CB106FBFP	L	Corner Base FH (400 Door) (Flexi C/Post)	1000/600/870	0.34
4	1	BU66F	L	Base Unit FH	600/600/870	0.20
5	1	BU66F3IDC	L	Base Unit FH w/1x Shallow Int. Drw & 2x Deep Int. Drw	600/600/870	0.20
5.1	1	HOBSHIELD6		Hobshield	600	
6	1	BU66F	R	Base Unit FH	600/600/870	0.20
7	1	BU46F	R	Base Unit FH	400/600/870	0.13
8	1	OH663AGL	R	Dbl Oven Hsg. (3A) (LH End)	600/600/2100	0.28
9	1	BU66FG2	L	Base Unit FH (2 Ends)	600/600/870	0.20
10	1	WU672	R	Wall Unit	600/300/724	0.10
11	1	WU672	R	Wall Unit	600/300/724	0.10
12	1	WU672	R	Wall Unit	600/300/724	0.10
13	1	CWU672	R	Corner Wall, No C/Post (300 Door)	600/300/724	0.10
14	1	WU672	L	Wall Unit	600/300/724	0.10
15	1	WU472GR	L	Wall Unit (RH End)	400/300/724	0.07
16	1	WU472GL	R	Wall Unit (LH End)	400/300/724	0.07
17	1	WU472	R	Wall Unit	400/300/724	0.07
18	1	WU672GL	L	Wall Unit (LH End)	600/300/724	0.10
	1	HOBSHIELD6		Hobshield	600	
	1	FRONTPNL72		Frontal Matched Filler Panel (For C/Post)	720	
	1	CONPLINTHR		Replacement End Matched Continuous Plinth (For Tall Filler)	2600	

Total cubic metres of storage

2.76

Worktop Details:

Default Style

Plan No.	Qty	Code	Description	Dims
----------	-----	------	-------------	------

19	1	PWT	40mm PVC Edged / 40mm Premium / 30mm Hi Def Worktop	3100/600
20	1	PWT	40mm PVC Edged / 40mm Premium Worktop	2800/600
	1	PFUP3095	Laminate Upstand	3000/95
	1	PFUP3095	Laminate Upstand	3000/95
	1	PFUP3095	Laminate Upstand	3000/95

Accessories and Trims:

Default Style

Qty	Code	Description	Dims
3	CONPLINTHR	Replacement End Matched Continuous Plinth w/Plinth Seal	2600
1	CTRAYVFH6	Standard Internal Cutlery Tray (For BU66F3ID/BU66F4ID)	600
2	RUNITPROTECT	Kitchen Protective Material	
1	SBACK675	Stainless Steel Splashback	600/750
1	TOPSEALBOLT	Topseal Easibolt Pack	
1	VENTGRIDGR	Aeration Grid Grey	510/45/15

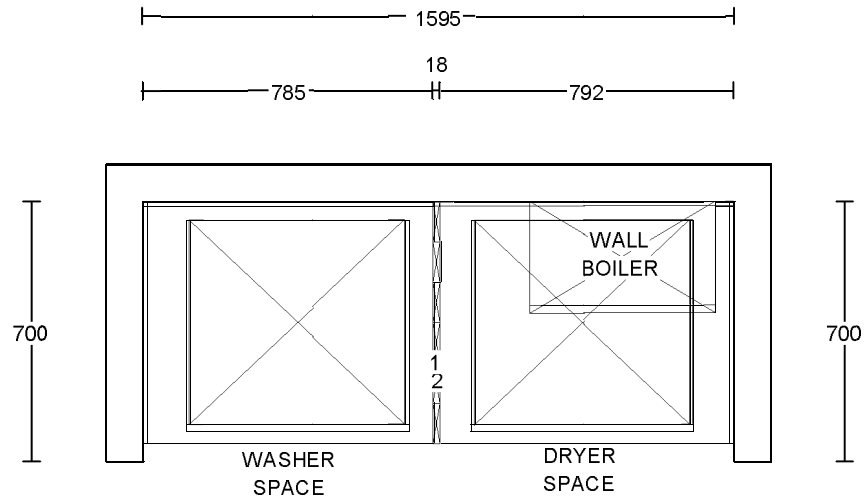

650mm DEEP WORKTOPS

PLEASE CHECK &
CONFIRM DIMENSIONS
& LAYOUT ON SITE
BEFORE ORDERING
CABINETS

Client:	BLOOR HOMES	Drawing No:	722806UA
Site:	CLASSICS RANGE	Revision No:	A
House Type:	CLASSIC 400 HILCOTT UTILITY	Scale:	Scale-to-fit
House Type 2:	UPGRADE		

Symphony[®]

**SCHEDULE &
CUBIC CAPACITY****Symphony**[®]

Client Name: BLOOR HOMES

Site Name: CLASSICS RANGE
2018 - LEVEL 2 ISSUE 4House Type: CLASSIC 400 HILCOTT UTILITY
UPGRADE

Drawing No: 722806UA

Revision No: A

Date Drawn: Fri, Jan 7, 2022

Revision Date: 13.12.21

Designed By:

CARA NORTCLIFF

Quote No:

Items on Plan:

Default Style

Plan No.	Qty	Code	Hdg	Description	Dims	CC (M3)
1	1	BBU6592R		Replacement End Matched Base Blender	650/920	
	1	BBU6592R		Replacement End Matched Base Blender 650/920 TO BOX BOILER PIPES		
	1	BBU6592R		Replacement End Matched Base Blender 650/920 TO BOX BOILER PIPES		

Total cubic metres of storage

Worktop Details:

Default Style

Plan No.	Qty	Code	Description	Dims
2	1	PWT	40mm PVC Edged / 40mm Premium / 30mm Hi Def Worktop	1700/650
	1	PFUP3095	Laminate Upstand	3050/95

Accessories and Trims:

Default Style

Qty	Code	Description	Dims
1	RUNITPROTECT	Kitchen Protective Material	

WE RECOMMEND A MINIMUM OF 70mm FOR TALL FILLERS

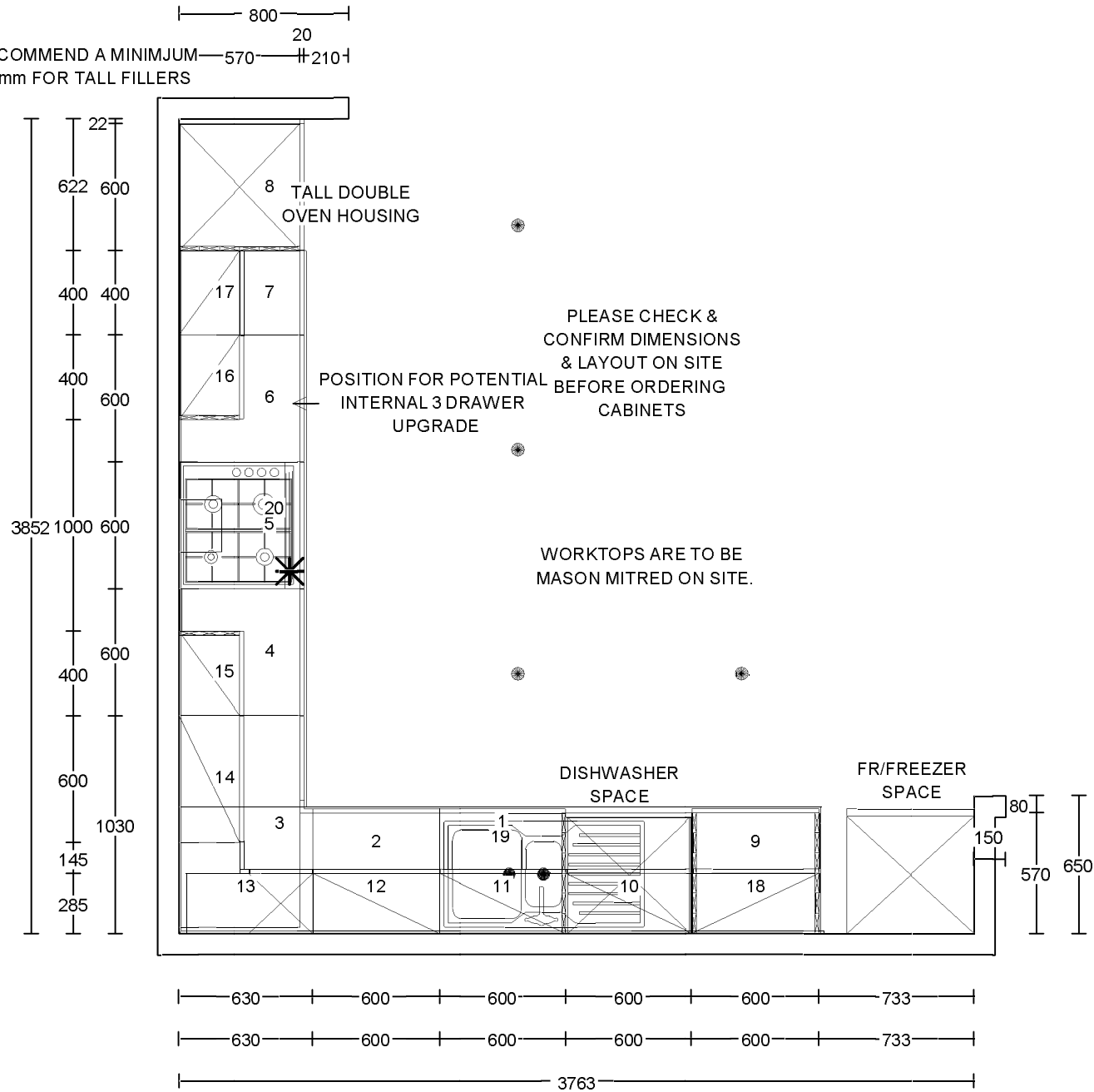

Client:	BLOOR HOMES	Drawing No:	722807__
Site:	CLASSICS RANGE	Revision No:	
House Type:	CLASSIC 400 HILCOTT EXCL. UTILITY	Scale:	Scale-to-fit
House Type 2:	EXCLUSIVE		

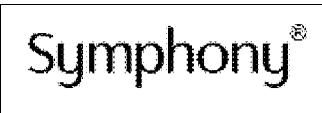

THIS DRAWING AND THE COPYRIGHT THEREIN IS THE PROPERTY OF THE SYMPHONY GROUP PLC. THIS DRAWING IS ISSUED ON THE CONDITION THAT IT MUST NOT BE USED, COPIED OR EXHIBITED WITHOUT THE WRITTEN PERMISSION OF THE SYMPHONY GROUP PLC. ANY COMPONENTS OR ARTICLES MADE IN ACCORDANCE WITH THIS DRAWING MUST NOT BE USED FOR ANY OTHER PURPOSE THAN FOR WHICH THE DRAWING IS ISSUED.

THIS PLAN IS OFFERED AS A GUIDE ONLY FOR APPROVAL BY OUR CUSTOMER. NO RESPONSIBILITY IS UNDERTAKEN FOR ITS ACCURACY IN RELATION TO ORDERS PLACED FOR THE FITTING OF OUR GOODS WITHIN THE DIMENSIONS SHOWN.

**SCHEDULE &
CUBIC CAPACITY**



Client Name:	BLOOR HOMES	Site Name:	CLASSICS RANGE 2018 - LEVEL 2 ISSUE 4
House Type:	CLASSIC 400 HILCOTT EXCL. UTILITY EXCLUSIVE		
Drawing No:	722807__	Revision No:	
Date Drawn:	Fri, Jan 7, 2022	Revision Date:	
Designed By:	CARA NORTCLIFF	Quote No:	

Items on Plan:

Default Style

Plan No.	Qty	Code	Hdg	Description	Dims	CC (M3)
1	1	SU66SLFGL	R	Sink Unit FH w/Sink Liner (LH End)	600/600/870	0.20
2	1	BU66F	R	Base Unit FH	600/600/870	0.20
3	1	CB106FBFP	L	Corner Base FH (400 Door) (Flexi C/Post)	1000/600/870	0.34
4	1	BU66F	L	Base Unit FH	600/600/870	0.20
5	1	BU66F3IDC	L	Base Unit FH w/1x Shallow Int. Drw & 2x Deep Int. Drw	600/600/870	0.20
5.1	1	HOBSHIELD6		Hobshield	600	
6	1	BU66F	R	Base Unit FH	600/600/870	0.20
7	1	BU46F	R	Base Unit FH	400/600/870	0.13
8	1	OH663AGL	R	Dbl Oven Hsg. (3A) (LH End)	600/600/2100	0.28
9	1	BU66FG2	L	Base Unit FH (2 Ends)	600/600/870	0.20
10	1	WU672	R	Wall Unit	600/300/724	0.10
11	1	WU672	R	Wall Unit	600/300/724	0.10
12	1	WU672	R	Wall Unit	600/300/724	0.10
13	1	CWU672	R	Corner Wall, No C/Post (300 Door)	600/300/724	0.10
14	1	WU672	L	Wall Unit	600/300/724	0.10
15	1	WU472GR	L	Wall Unit (RH End)	400/300/724	0.07
16	1	WU472GL	R	Wall Unit (LH End)	400/300/724	0.07
17	1	WU472	R	Wall Unit	400/300/724	0.07
18	1	WU672GL	L	Wall Unit (LH End)	600/300/724	0.10
	1	HOBSHIELD6		Hobshield	600	
	1	FRONTPNL72		Frontal Matched Filler Panel (For C/Post)	720	
	1	CONPLINTHR		Replacement End Matched Continuous Plinth (For Tall Filler)	2600	

Total cubic metres of storage

2.76

Worktop Details:

Default Style

Plan No.	Qty	Code	Description	Dims
----------	-----	------	-------------	------

19	1	PWT	40mm PVC Edged / 40mm Premium / 30mm Hi Def Worktop	3100/600
20	1	PWT	40mm PVC Edged / 40mm Premium Worktop	2800/600
	1	PFUP3095	Laminate Upstand	3000/95
	1	PFUP3095	Laminate Upstand	3000/95
	1	PFUP3095	Laminate Upstand	3000/95

Accessories and Trims:

Default Style

Qty	Code	Description	Dims
3	CONPLINTHR	Replacement End Matched Continuous Plinth w/Plinth Seal	2600
1	CTRAYVFH6	Standard Internal Cutlery Tray (For BU66F3ID/BU66F4ID)	600
1	GLSPASH675	Glass Splashback	600/750
2	RUNITPROTECT	Kitchen Protective Material	
1	TOPSEALBOLT	Topseal Easibolt Pack	
1	VENTGRIDGR	Aeration Grid Grey	510/45/15

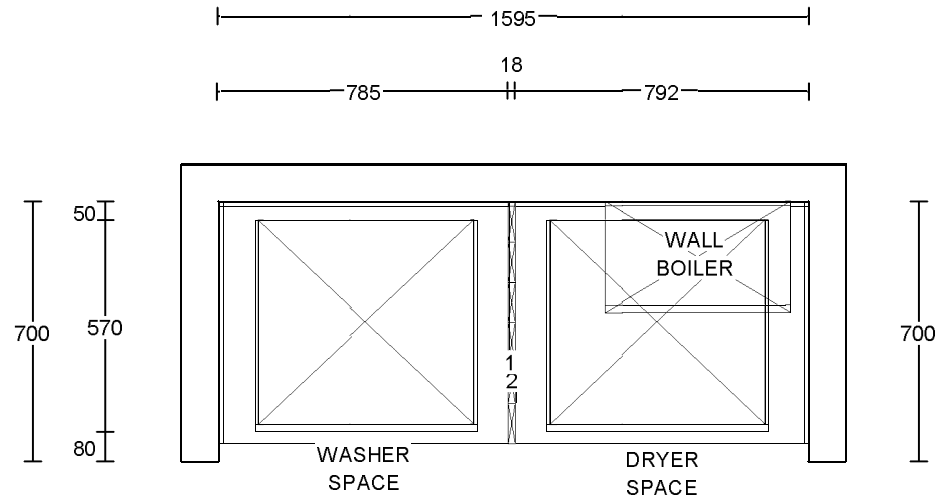

650mm DEEP WORKTOPS

PLEASE CHECK &
CONFIRM DIMENSIONS
& LAYOUT ON SITE
BEFORE ORDERING
CABINETS

Client:	BLOOR HOMES	Drawing No:	722807UA
Site:	CLASSICS RANGE	Revision No:	A
House Type:	CLASSIC 400 HILCOTT UTILITY	Scale:	Scale-to-fit
House Type 2:	EXCLUSIVE		

Symphony[®]

THIS DRAWING AND THE COPYRIGHT THEREIN IS THE PROPERTY OF THE SYMPHONY GROUP PLC. THIS DRAWING IS ISSUED ON THE CONDITION THAT IT MUST NOT BE USED, COPIED OR EXHIBITED WITHOUT THE WRITTEN PERMISSION OF THE SYMPHONY GROUP PLC. ANY COMPONENTS OR ARTICLES MADE IN ACCORDANCE WITH THIS DRAWING MUST NOT BE USED FOR ANY OTHER PURPOSE THAN FOR WHICH THE DRAWING IS ISSUED.

THIS PLAN IS OFFERED AS A GUIDE ONLY FOR APPROVAL BY OUR CUSTOMER. NO RESPONSIBILITY IS UNDERTAKEN FOR ITS ACCURACY IN RELATION TO ORDERS PLACED FOR THE FITTING OF OUR GOODS WITHIN THE DIMENSIONS SHOWN.

**SCHEDULE &
CUBIC CAPACITY**



Client Name:	BLOOR HOMES	Site Name:	CLASSICS RANGE 2018 - LEVEL 2 ISSUE 4
House Type:	CLASSIC 400 HILCOTT UTILITY EXCLUSIVE		
Drawing No:	722807UA	Revision No:	A
Date Drawn:	Fri, Jan 7, 2022	Revision Date:	13.12.21
Designed By:	CARA NORTCLIFF	Quote No:	

Items on Plan: Default Style

Plan No.	Qty	Code	Hdg	Description	Dims	CC (M3)
1	1	BBU6592R		Replacement End Matched Base Blender	650/920	
	1	BBU6592R		Replacement End Matched Base Blender 650/920 TO BOX BOILER PIPES		
	1	BBU6592R		Replacement End Matched Base Blender 650/920 TO BOX BOILER PIPES		

Total cubic metres of storage

Worktop Details: Default Style

Plan No.	Qty	Code	Description	Dims
2	1	PWT	40mm PVC Edged / 40mm Premium / 30mm Hi Def Worktop	1700/650
	1	PFUP3095	Laminate Upstand	3050/95

Accessories and Trims: Default Style

Qty	Code	Description	Dims
1	RUNITPROTECT	Kitchen Protective Material	